

MAXHUB

Integrated video conference terminal Quick Start Guide

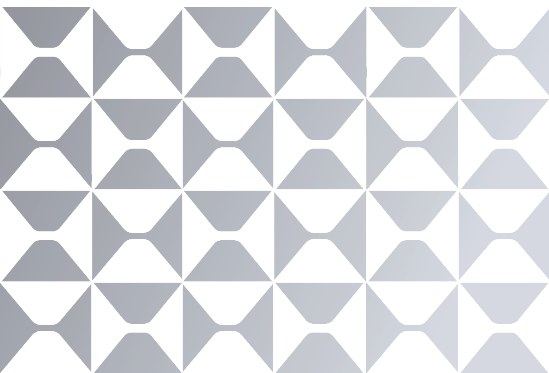

MAXHUB

All the pictures in this manual are for reference only, subject to our available products.

1. FCC Caution:

This device complies with Part 15 of the FCC Rules. Operation is subject to the following two conditions: (1) This device may not cause harmful interference, and (2) this device must accept any interference received, including interference that may cause undesired operation.

2. Federal Communication Commission Interference Statement

This equipment has been tested and found to comply with the limits for a Class B digital device, pursuant to Part 15 of the FCC Rules. These limits are designed to provide reasonable protection against harmful interference in a residential installation. This equipment generates, uses, and can radiate radio frequency energy and, if not installed and used in accordance with the instructions, may cause harmful interference to radio communications. However, there is no guarantee that interference will not occur in a particular installation. If this equipment does cause harmful interference to radio or television reception, which can be determined by turning the equipment off and on, the user is

encouraged to try to correct the interference by one or more of the following measures:

- Reorient or relocate the receiving antenna.
- Increase the separation between the equipment and receiver.
- Connect the equipment into an outlet on a circuit different from that to which the receiver is connected.
- Consult the dealer or an experienced radio/TV technician for help.



■ This symbol, affixed to the product or its packaging, indicates that the product must not be processed with household waste. It must be brought to an electric and electronic waste collection point for recycling and disposal. By the appropriate disposal of this product you also help in preventing potentially negative consequences for the environment and human health. The recycling of materials helps preserve our natural resources. For further information regarding the recycling of this product, please contact your municipality, local waste disposal centre or the store where the product was purchased.

3. What's in the box

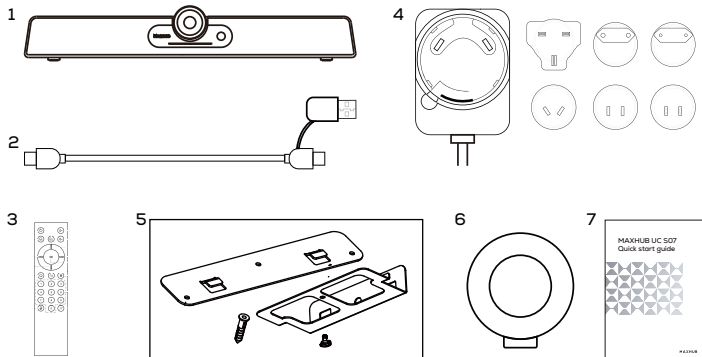

1 MAXHUB UC S07

2 USB Type-C Cable (1.8m/70.9 inch)

3 Remote Control (uses with AAA batteries x2, not included)

4 Power Adapter (with regional plugs)

5 Wall-Mounted kit

6 Peeping Cover

7 UC S07 Quick start guide

4. Hardware info

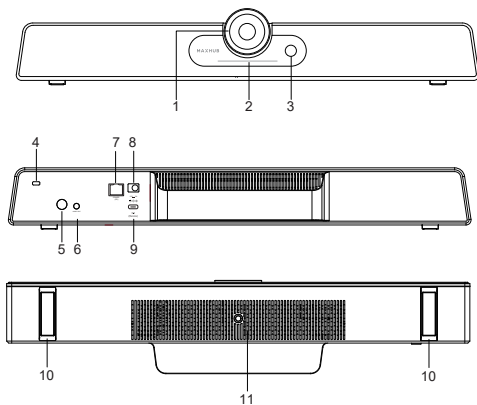







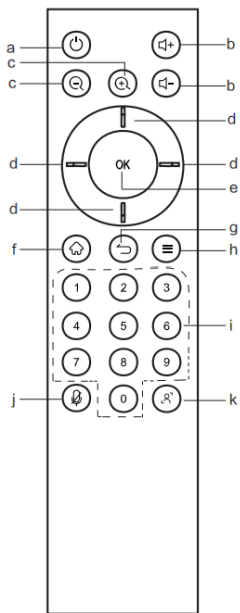

- | | |
|---|------------------------------------------------------------------------------------------------------------------------------------------------------------------------------------------------------------------------------------------------------------------------|
| 1 | Camera |
| 2 | Indicator light |
| 3 | The Passive Infrared (PIR) sensor: operates in power-on mode and will automatically enter standby state if no motion is detected within 3 meters for 30 minutes. In standby mode, the PIR sensor will automatically activate when motion is detected within 3 meters.. |

- | | |
|----|------------------------------------------------------------------------------------------------------------------------|
| 4 | Kensigton lock |
| 5 | Power Button: In startup mode, press the power button to mute.
In standby mode, press the power button to power on. |
| 6 | AUDIO OUT: Used for external audio equipment |
| 7 | RJ45: Only support POE power supply |
| 8 | DC: Used for power input supply at 12V. |
| 9 | USB 3.0(Device): Connect to USB host (eg: PC / Laptop), firmware upgrade, etc. |
| 10 | 1/4" screw hole for mounting on bracket or tripod |
| 11 | Foot stand for placing on table top |

5. Remote control



- a. : Power Button, press to enter Energy-saving state, Press and hold for 2 seconds to power off.
 - b. : Volume Button, press to adjust the system volume.
 - c. : Digital Zooming, press to digitally zoom the camera. After zooming in, the direction button may move the camera image.
 - d. : Direction Button, Press the direction buttons for selection.
 - e. OK Button: Confirm the selection. During digital zooming, press this button would restore the default view.
 - f. : Invalid
 - g. : Invalid
 - h. : Invalid
 - i. Number keys : Digital input .
 - j. : Turn on/off the microphone.
 - k. : It needs to be used with MAXHUB ALIGN:
Turn on DOA: Auto Framing and voice tracking;
DOA OFF: Auto Framing.
- Note: The default is to turn on.

Presets :

- (1) Smart View mode is off, on the video conferencing page or open the camera field In view, the camera preset mode can be set and switched.
- (2) Press the Number keys 2 seconds to save the current camera settings (A total of 10, press and hold to set the preset, short press to switch the preset position).
- (3) Short press of Number keys can switch the corresponding preset state.

6. Placement

Mounting height should be as close to eye level as possible

Method 1:

Place on the top of table.

Example :

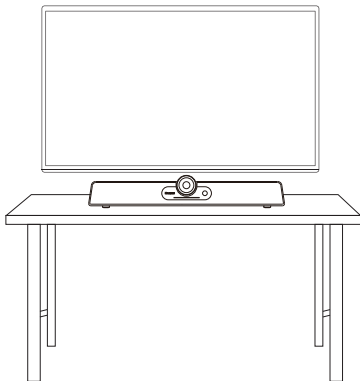

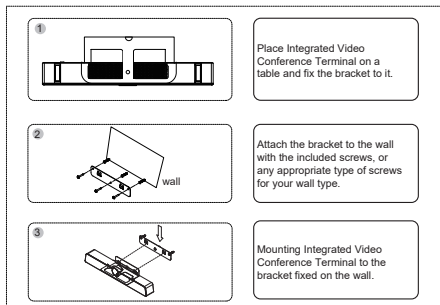
Method 2:

Wall-mounted: Fix the bracket onto the Wall with screws.

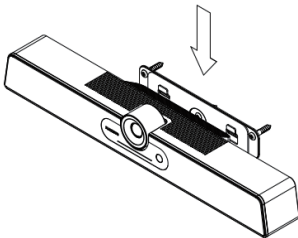

7. Connection guide

1. Connect UC S07 to your laptop or PC to get started

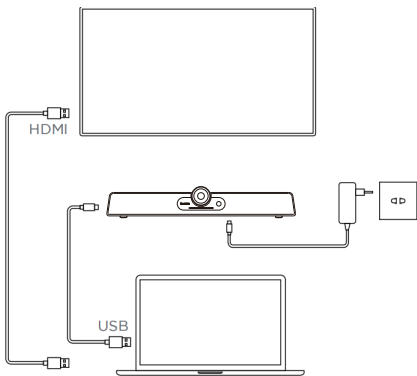

Please follow the instructions below to properly connect the device before use:

- ① Connect the power jack of the power adaptor to the product.
- ② Use the included USB-C cable to connect this product to the computer.
- ③ Connect the other end of the USB Cable to your computer's USB port.
- ④ Connect the PC to the display using an HDMI Cable

Notes:

- The product will automatically power up when the power outlet is switched on.
- You may manually turn on the product by pressing the Power button located at the back of the unit.
- The supplied power cord is suitable for use with 100-240V AC power only.
- Please be aware of the power loading when using extension cords or multiple outlet power boards.
- The illustration provided is for reference purposes only.

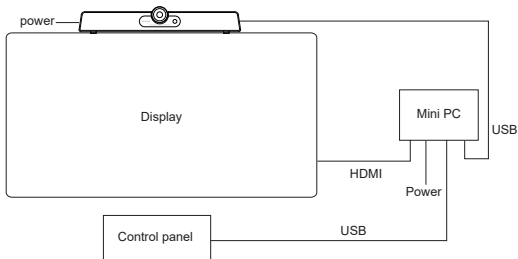
2. Meeting room with dedicate In-room system

Support

Firmware Update

To improve the performance and add new functionality to the product, we recommend updating the firmware. To perform the firmware update, please download and install the MAXHUB Align software. This software also allows you to control and configure the audio and video attributes of the product. For detailed instructions, please visit our website at <https://www.maxhub.com> to download the latest version of MAXHUB Align and the User Manual.

More information are available on MAXHUB WEBSITE :

<https://www.maxhub.com/en/support-uc>



Download Center



FAQ



Warranty



Hot Swap Request

MAXHUB

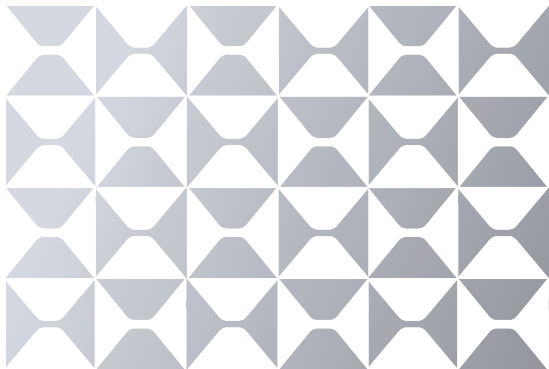

 www.maxhub.com/en/

 sales@maxhub.com

 [MAXHUB](#)

 [MAXHUB.Global](#)

 [maxhub-overseas/](#)